

10' X 10' EVENT TENT SET UP INSTRUCTIONS

Product Parts

- 1 - Frame
- 2- Soft Case with Wheels
- 3- Canopy
- 4- Stake Kit

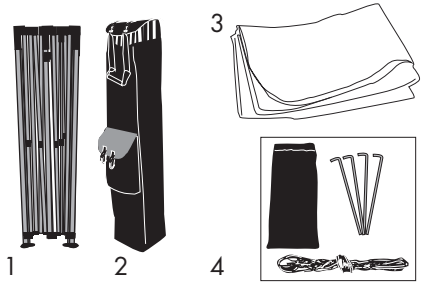

NOTE:

Standard & Premium Tent Frames have same set up instructions. However, Standard Frames have a push button height adjustment See below:

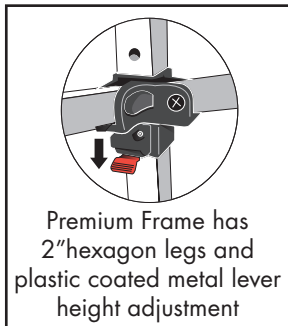
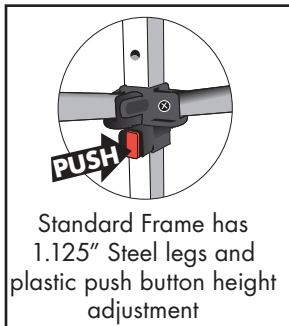

Watch the Standard Event Tent Instructional Video:
https://youtu.be/mn_j_kSIA1A

Watch the Premium Event Tent Instructional Video:
https://youtu.be/Td_e8VYSi0Q

Set-Up

Step 1

Remove the Frame (1) from the Soft Case (2) and place it at your desired location.

In tandem with another person, separate the legs of the Frame (1) until they are extended a full arms length.

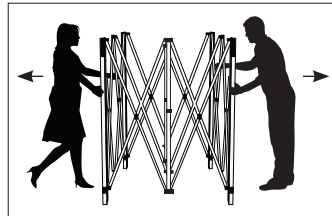

Step 2

Unfold your Canopy (3) and drape over the Frame (1). Position the apex of the Canopy (3) with the center pole of the Frame (1).

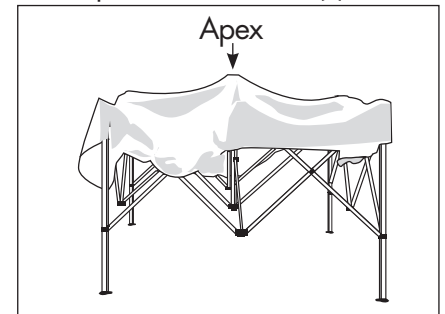

Step 3

Attach the Canopy (3) by connecting the loop strips on the Canopy (3) corners with the hook strips on the four legs of the Frame (1).

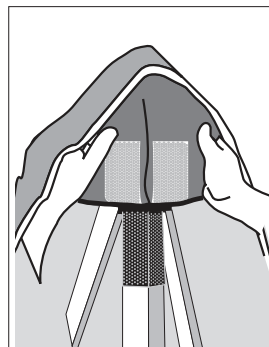

Step 4

Stand diagonal to each other, lift and separate the legs of the Frame (1). The Frame (1) will open a little at a time so alternate ends until the Frame (1) no longer expands.

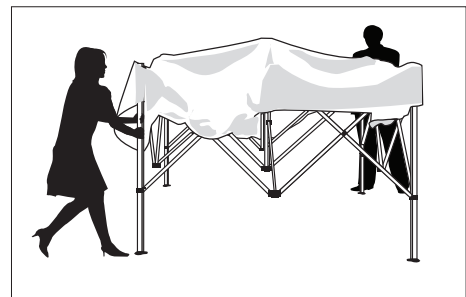

DO NOT DRAG FRAME-THIS COULD BEND THE LEGS

Set-Up Continued...

Step 5

Unlock the Height Adjustment connectors (lever or button) on Frame (1) legs. With connector in unlock position, lift the framework upwards until the four sliding connectors lock into place on the legs of the Frame (1).

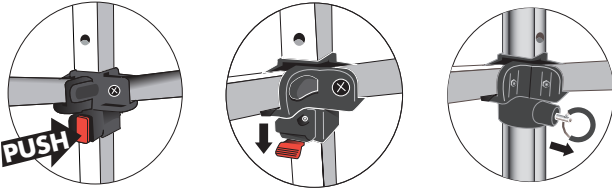
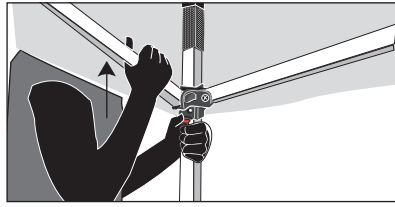

Push down lever,
Push in button OR Pull Pin
(method depends on the frame)

Step 7

Lift the apex of the Canopy (3) into place by turning the crank clockwise until the Canopy (3) is taut.

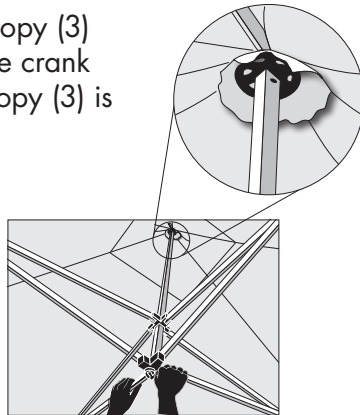

Step 6

Place your foot on the base of the tent leg as you release and extend the telescoping legs. Raise the tent to your desired height and lock the legs into place.



Place your foot on
the base as you lift

NOTE:

To move an assembled frame, make sure a person is located at each leg. Lift and transport carefully in unison.

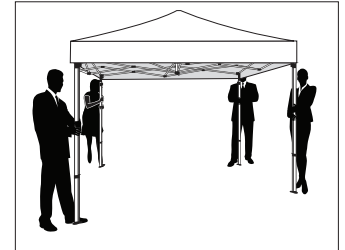

Secure with Stakes

Secure by looping rope through the "D" ring located on each tent corner.

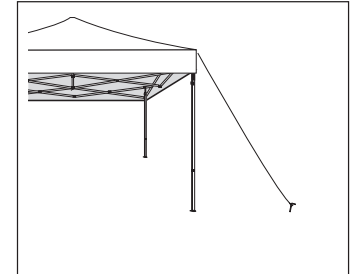
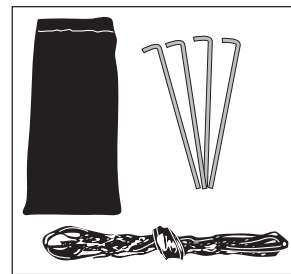

***FRAME MUST BE SECURED DOWN TO PREVENT WIND FROM LIFTING TENT AND CAUSING DAMAGE. NOT SECURING TENT PROPERLY VOIDS THE WARRANTY.**

Warranty

All products are designed to provide the user with a cost-effective and durable product. Standard warranty is a 'one year parts and labor'** warranty which warrants product against defects in material and workmanship. It does not cover damage due to accidents, abuse, or normal wear and tear. Products found to be defective will be replaced or repaired at factory's discretion.

**STANDARD FRAME=1YEAR / PREMIUM FRAME=3YEAR parts and labor.

Storage

Remove Canopy (3) from Frame (1) and collapse. Store collapsed Frame (1) in soft case (provided) as well as folded Canopy (3) in front pocket.

Store in a cool dry location.
To clean, wipe with damp cloth.



Soft Case 220079-provided

MAKE SURE TO TAKE SPECIAL CARE TO NOT DRAG THE FRAME WHEN SETTING UP OR TAKING DOWN.